

WLC

WLC/A1/C/2 Precision Scale
WLC/A2/C/2 Precision Scale
WLC/A2 Precision Scale

USER MANUAL

ITKU-105-08-11-18-EN



 **RADWAG BALANCES AND SCALES**
ADVANCED WEIGHING TECHNOLOGIES

NOVEMBER 2018

CONTENTS

1. GENERAL INFORMATION	5
2. PRECAUTIONS	5
2.1. Operation	5
2.2. Battery Power Supply	5
2.3. Operation under Conditions Difficult due to Electrostatics	6
3. WARRANTY CONDITIONS	6
4. DESIGN	7
4.1. Dimensions	7
4.2. Connectors Arrangement	8
4.3. Pins Overview	8
5. UNPACKING AND INSTALLATION	9
5.1. Under-Pan Weighing	9
6. START-UP AND OPERATION	10
6.1. Levelling	10
6.2. Connecting the Scale to the Mains	10
6.3. Warm-Up Time	11
6.4. Battery Charge Status	11
6.5. Battery Charge Status Check	12
7. MAINTENANCE ACTIVITIES	12
7.1. Cleaning ABS Components	12
7.2. Cleaning Glass Components	12
7.3. Cleaning Stainless Steel Components	13
7.4. Cleaning Powder-Coated Components	13
7.5. Cleaning Aluminium Components	13
8. OPERATION PANEL	14
9. KEYS	14
10. PROGRAM STRUCTURE	15
10.1. Function Groups	15
10.2. Operating the Menu	16
10.3. Return to the Weighing Mode	16
11. WEIGHING OPERATION	16
11.1. Good Weighing Practice	17
11.2. Zeroing	17
11.3. Taring	18
11.4. Entering Tare Value Manually	18
11.5. Dual Range Devices	18
11.6. Units	19
11.6.1. Start Unit	19
11.6.2. Temporary Unit	20
12. ADJUSTMENT	20
12.1. External Adjustment	21
12.2. User Adjustment	22
12.3. Manual Internal Adjustment	22
12.4. Automatic Internal Adjustment	23
12.5. Automatic Internal Adjustment Time	24
12.6. Adjustment Test	24
12.7. Adjustment Report	25
13. SCALE PARAMETERS	25
13.1. Filter	25
13.2. Value Release	25
13.3. Ambient Conditions	26
13.4. Autozero Function	26
13.5. Tare Function	26
13.6. Tare: Enter Mode	27
13.7. Tare: Values Memory	27
13.7.1. Entering Tare Value to the Weighing Device Memory	27
13.7.2. Selecting Tare Value from the Weighing Device Memory	28
13.8. Last Digit	28
14. COMMUNICATION	29
14.1. RS232 (1) Port Settings	29
14.2. RS232 (2) Port Settings	29
14.3. USB A Port	29

14.4. USB B Port	30
15. PERIPHERAL DEVICES.....	32
15.1. Computer	32
15.1.1. Computer Port	32
15.1.2. Continuous Transmission	32
15.1.3. Printout Interval for Continuous Transmission	33
15.2. Printer	33
15.2.1. Printer Port	33
15.3. Additional Display.....	33
15.3.1. Additional Display Port	34
16. PRINTOUTS	34
16.1. Adjustment Report	34
16.2. GLP Printout	35
17. MISCELLANEOUS PARAMETERS.....	36
17.1. Backlight	36
17.2. 'Beep' Sound	36
17.3. Automatic Shutdown	36
17.4. Date and Time.....	37
17.5. Default User Settings	37
18. SCALE DATA	38
19. WORKING MODES – General Information.....	38
19.1. Running Working Mode.....	38
19.2. Working Modes Local Settings	39
19.2.1. Working Mode Accessibility	39
19.2.2. Save Mode.....	39
19.2.3. Automatic Printout Time Interval.....	40
19.2.4. Lo Threshold	40
20. WORKING MODE – WEIGHING.....	41
20.1. Local Settings.....	41
21. WORKING MODE – PARTS COUNTING	41
21.1. Local Settings.....	41
21.1.1. Selecting Operation Mode	41
21.2. Setting Sample Mass by Entering Mass of a Single Part	42
21.3. Setting Sample Mass by Determining Mass of a Single Part	42
22. WORKING MODE – +/- CONTROL	43
22.1. Local Settings.....	43
22.2. Declaring Checkweighing Thresholds	43
23. WORKING MODE – PERCENT WEIGHING.....	44
23.1. Local Settings.....	44
23.1.1. Selecting Operation Mode	44
23.2. Reference Sample Mass Determined by Weighing	45
23.3. Reference Sample Mass Determined by Entering the Mass Value.....	45
24. WORKING MODE – PEAK HOLD	45
24.1. Local Settings.....	45
24.2. Peak Hold Operation	46
25. WORKING MODE – TOTALIZING.....	46
25.1. Local Settings.....	46
25.2. Totalizing Operation	46
26. WORKING MODE – ANIMAL WEIGHING.....	47
26.1. Local Settings.....	48
26.2. Animal Weighing Operation.....	48
27. IMPORT / EXPORT	48
27.1. Weighing Records Export	49
27.2. ALIBI Weighings Export	49
27.3. Parameters Export / Import	49
28. INPUTS / OUTPUTS.....	50
28.1. Inputs / Outputs Parameters.....	50
28.2. Inputs Setup	50
28.3. Outputs Setup	51
29. DIAGRAMS OF CONNECTION CABLES	52
30. TROUBLESHOOTING	53
31. ERROR MESSAGES	53

1. GENERAL INFORMATION

WLC/A1, WLC/A2 precision scales enable fast and accurate mass measurements under laboratory and industrial conditions. The devices are equipped with an internal battery which allows their operation in places where there is no access to the mains. The WLC series features a stainless steel weighing pan, and a backlit LCD guaranteeing clear weighing result presentation.

WLC/A1, WLC/A2 precision scales are equipped with the following interfaces: 2 x RS232, USB type A, and USB type B. The interfaces enable cooperation between the scale and peripheral devices (e.g. printer, computer, USB flash drive).





2. PRECAUTIONS

2.1. Operation

- A. Prior the first use, carefully read this User Manual. Use the device only as intended.
- B. Indicators to be decommissioned must be decommissioned in accordance with valid legal regulations.

2.2. Battery Power Supply

WLC/A1, WLC/A2 series scales are devices intended to be supplied by **SLA** battery (*sealed lead acid*) of **3 - 4 Ah** capacity.

	<i>Do not let battery discharge in case of prolonged storage of the device in low temperature.</i>
	<i>Accumulators do not belong to regular household waste. The European legislation requires discharged accumulators to be collected and disposed separately from other communal waste with the aim of being recycled. Dear user, you are obliged to dispose of the worn out batteries as regulated.</i>
	<i>Notice: Symbols on batteries identify harmful compounds: Pb = lead, Cd = cadmium, Hg = mercury.</i>
	<i>A worn out battery can be replaced only by the manufacturer or by the authorized service.</i>

2.3. Operation under Conditions Difficult due to Electrostatics

If the device is to be operated in a place characterized with conditions that are difficult due to electrostatics (e.g. printing house, packing centre, etc.), you must connect it to the earth wire. To enable this, the device features functional earthing terminal, marked with  symbol.

3. WARRANTY CONDITIONS

- A. RADWAG feels obliged to repair or exchange all elements that appear to be faulty by production or by construction.
- B. Defining defects of unclear origin and means of their elimination can only be realized with assistance of manufacturer and user representatives.
- C. RADWAG does not bear any responsibility for damage or losses resulting from unauthorized or inadequate performing of production or service processes.
- D. The warranty does not cover:
 - mechanical damage caused by product exploitation other than intended, damage of thermal and chemical origin, damage caused by lightning, overvoltage in the power network or other random event,
 - inappropriate cleaning habits.
- E. Loss of warranty takes place if:
 - a repair is carried out outside RADWAG authorized service point,
 - service claims intrusion into mechanical or electronic construction by unauthorized people,
 - the device does not bear company security stickers.
- F. Warranty conditions outline the warranty period for rechargeable batteries attached to the device for 12 months.
- G. For detailed warranty conditions read the warranty certificate.
- H. Contact with the central authorized service: +48 48 384 88 00 ext. 106 and 107.

4. DESIGN

4.1. Dimensions

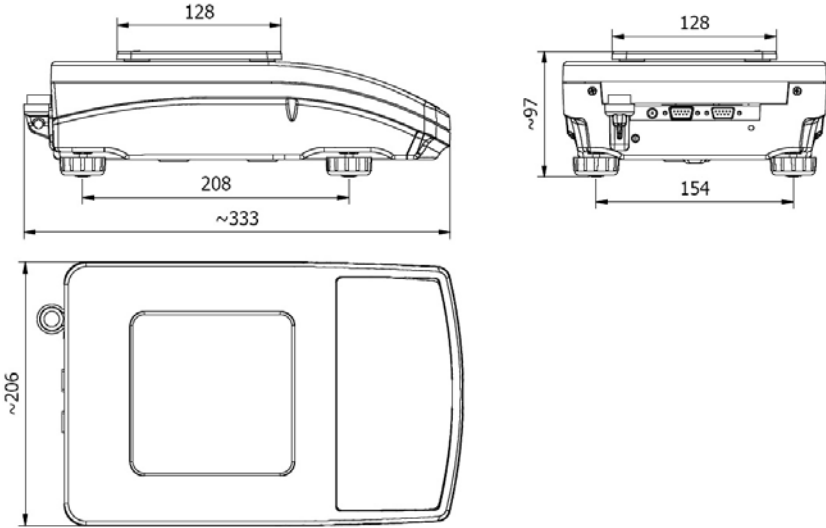

Figure 1a. WLC/A1 precision scale

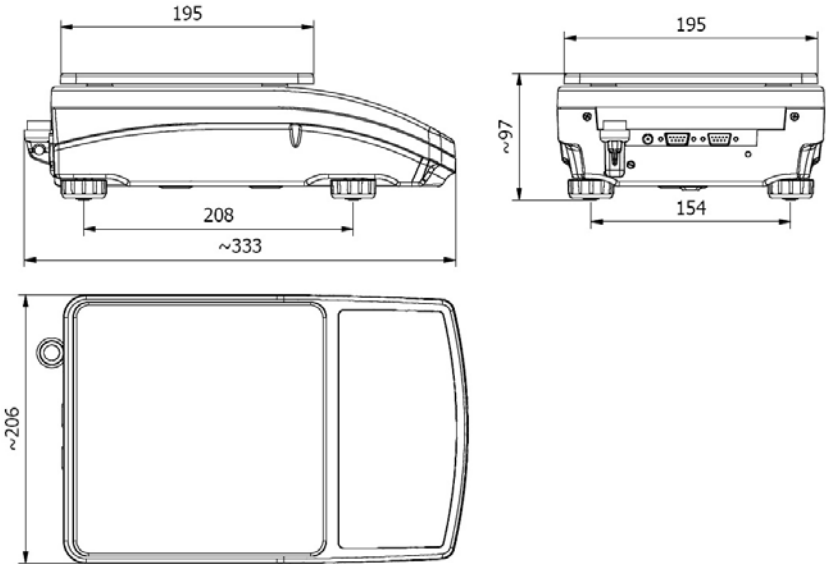

Figure 1b. WLC/A2 precision scale

4.2. Connectors Arrangement

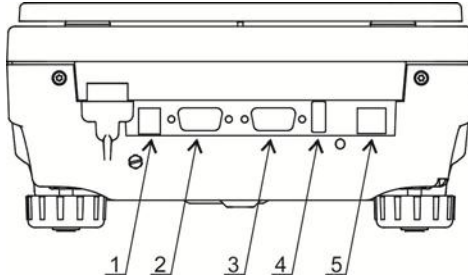

Figure 2. Connectors view

- 1- power supply socket 12 VDC
- 2- RS232 (1) connector
- 3- RS232 (2) connector
- 4- USB A "host"
- 5- USB B "device"

4.3. Pins Overview

	<p>Pin2 – RxD Pin3 – TxD Pin4 – 5 VDC Pin5 – GND</p>	<p>RS232 (1) connector DB9/M (male)</p>
	<p>Pin1 - GNDWE Pin2 - OUT1 Pin3 - OUT2 Pin4 - COMM Pin6 - IN4 Pin7 - IN3 Pin8 - TxD2 Pin9 - 5 VDC Pin10 - GNDRS Pin11 - IN2 Pin12 - IN1 Pin13 - RxD2 Pin14 - OUT4 Pin15 - OUT3</p>	<p>IN/OUT, RS232 (2) connector DSUB15/F (female)</p>

5. UNPACKING AND INSTALLATION

- Unpack the device and place it on a flat and even surface. Keep it far away from any sources of heat.
- Install the weighing pan, follow the below figures:

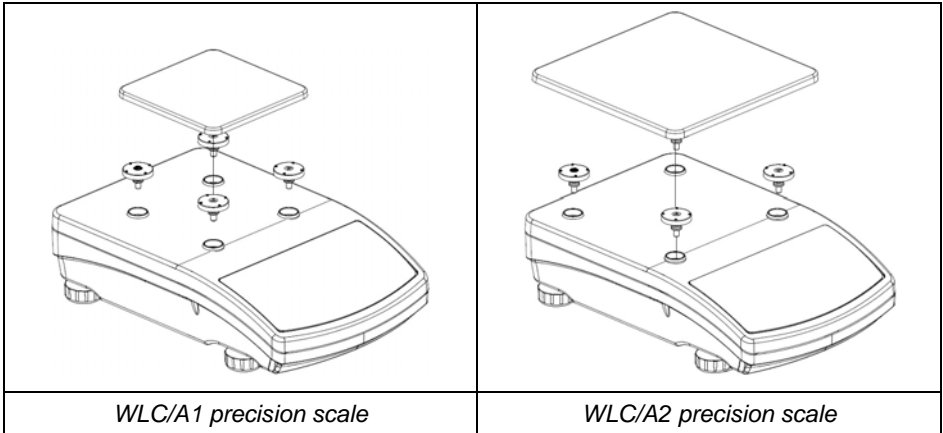

5.1. Under-Pan Weighing

The WLC/A1, WLC/A2 scales enable weighing loads below scale (so called under-pan weighing). This is an alternative for loads of non-standard dimensions and shapes, and for loads generating magnetic field.

Preparing the scale for the under-pan weighing:

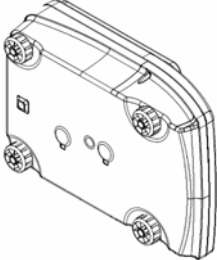
<p>1. Unpack the scale, assembly it following section 5 of this user manual.</p>	<p>-</p>
<p>2. Put the scale right side down.</p>	

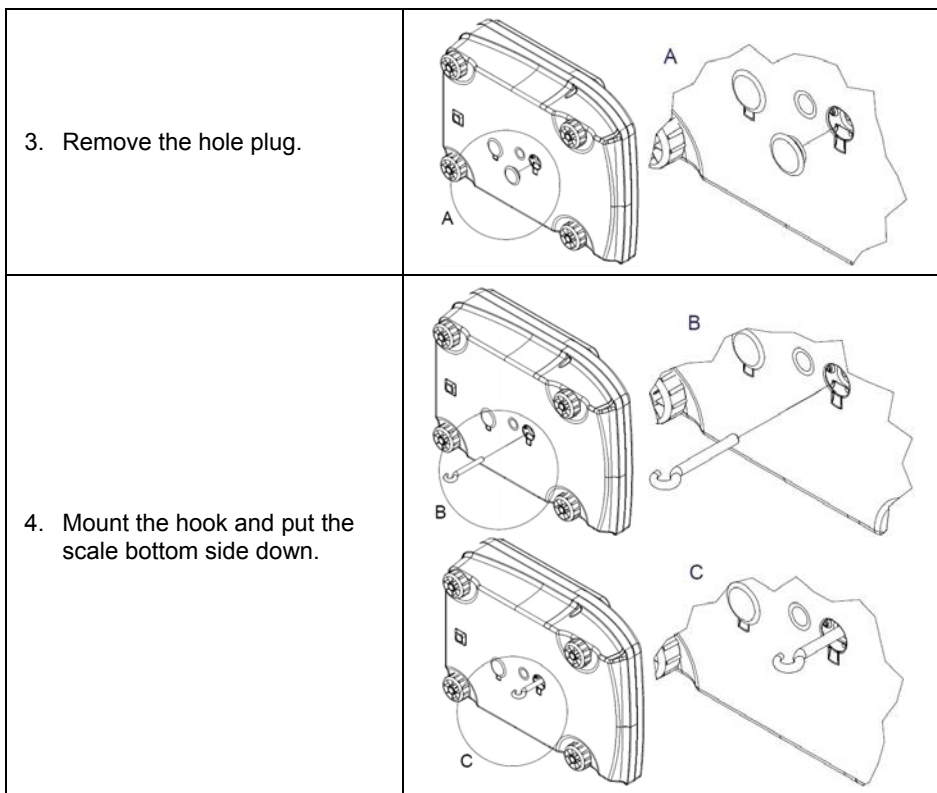

6. START-UP AND OPERATION

6.1. Levelling

To level the weighing instrument turn its feet. Keep turning the feet until the air bubble takes central position:

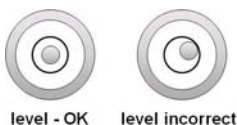



6.2. Connecting the Scale to the Mains

The weighing device can be connected to the mains only with a power supply that comes standard with the particular model.

Nominal voltage of the power supply (specified on the power supply data plate) has to be compatible with the mains nominal voltage.

Procedure:

- Connect the power supply to the mains. Plug it to the power supply socket (back side of the scale housing).
- Press  key. The key is also used to switch the scale on/off.
- Display test proceeds (all symbols are backlit for a moment), program name and number is displayed first, ZERO indication with reading unit next (displayed reading unit is conditioned by scale type).
- In case the weighing result is not zero after indication stabilisation, press  key.

6.3. Warm-Up Time

- For correct scale operation, the workroom temperature must range between +15°C ÷ +30°C.
- It takes 30 minutes for the device to warm up.
- During the thermal stabilization, the indications on the screen can change.
- If you want to carry out adjustment operation, make sure that your device is thermally stable.
- Temperature and humidity variations during operation may cause indication errors. To remove the indication errors perform user adjustment.



6.4. Battery Charge Status

The scale of standard design is equipped with an internal battery. Battery state is signalled by  pictogram, the pictogram is displayed in the top bar of the display.

 pictogram display mode	Meaning
No pictogram	Battery charged. Regular scale operation.
Pictogram displayed continuously	Too low battery charge (the scale is about to shut down). Charge the battery immediately.
Blinking pictogram, blink frequency: ca. 1 s	Battery charge in progress. The device is connected to the power supply charging the battery.
Blinking pictogram, blink frequency: ca. 0.5 s	Battery error. Battery is damaged.

6.5. Battery Charge Status Check



- Press  and  keys combination.
- Battery charge state, given in %, is displayed for 2 s.
- Next, home screen is displayed automatically.

7. MAINTENANCE ACTIVITIES

In order to ensure safety in the course of cleaning, it is necessary to disconnect the device from the mains. With this condition met, uninstall the weighing pan and other detachable components.



Cleaning the weighing pan while still installed may cause damage of the measuring system.

7.1. Cleaning ABS Components

To clean dry surfaces and avoid smudging, use clean non-colouring cloths made of cellulose or cotton. You can use a solution of water and detergent (soap, dishwashing detergent, glass cleaner). Gently rub the cleaned surface and let it dry. Repeat cleaning process if needed.

In the case of hard to remove contamination, e.g. residues of adhesive, rubber, resin, polyurethane foam etc., you can use a special cleaning agents based on a mixture of aliphatic hydrocarbons that do not dissolve plastics. Before using the cleanser for all surfaces we recommend carrying out tests. Do not use cleansers containing abrasive substances.

7.2. Cleaning Glass Components

Select dissolvent depending on a dirt. Never soak the glass panes in alkaline solutions since they interact with glass and may cause damage. Do not use cleansers containing abrasive substances.

For organic dirt use acetone first, next use water or detergent. For other than organic dirt use diluted acid solutions (soluble salts of hydrochloric or nitric acid) or base solutions (ammonium or sodium base). To remove ACIDS use protophilic solvent (sodium carbonate), to remove BASE use protogenic solvent (mineral acid of various concentration).

In case of heavy contamination use brush and detergent, nevertheless avoid detergents containing large and hard molecules which could potentially scratch glass panes.

At the end of the cleaning process rinse the pane using distilled water. Use soft brush with wooden or plastic handle exclusively in order to avoid risk of scratches. Do not use wire brush. Rinsing is a necessary cleaning process stage allowing to remove remaining soap, detergents and other cleansers from the panes prior their reinstallation. After preliminary cleaning process stage, rinse the pane using running water first, distilled next.

Avoid drying the panes either using paper towel or forced air circulation since some fibres, grains or contamination of other type could permeate into the panes thus causing weighing errors. We do not recommend using driers when drying measuring glass tools. It is a frequent treatment to leave glass components on a rack to dry.

7.3. Cleaning Stainless Steel Components

Avoid using cleansers containing any corrosive chemicals, e.g. bleach (including chlorine). Do not use cleansers containing abrasive substances. Always remove the dirt using microfiber cloth to avoid damage of protective coating.

In case of a daily maintenance:

1. Remove the dirt using cloth dipped in warm water.
2. For best results, add a little bit of dishwashing detergent.

7.4. Cleaning Powder-Coated Components

For preliminary cleaning process stage you need running water or wet sponge featuring large holes, this will help you to remove loose, heavy dirt. Do not use cleansers containing abrasive substances.

Next, using cloth and cleanser-water solution (soap, dishwashing liquid) gently rub the cleaned surface.

Avoid using cleanser without water since it may result with damage of the cleaned surface, please mind that large amount of water mixed with cleanser is a must.

7.5. Cleaning Aluminium Components

While cleaning aluminium components use products acid by nature, e.g. spirit vinegar, lemon. Do not use cleansers containing abrasive substances. Avoid using hard brush, this may cause scratches. It is recommended to use microfibre cloth.

While polishing the surface use circular movements. Use clean, dry cloth to make the surface shine.

8. OPERATION PANEL

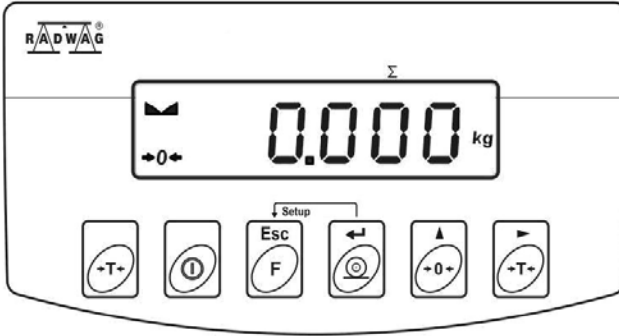

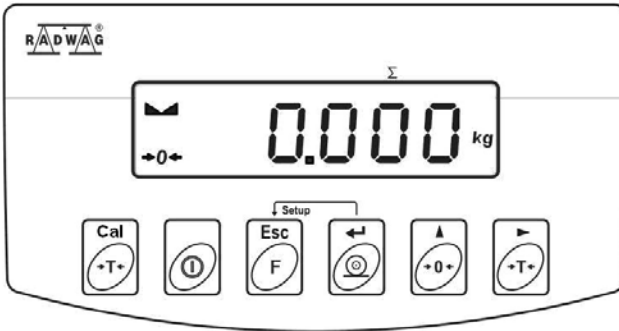

Operation panel of WLC/A2 precision scale







Operation panel of WLC/A1/C/2, WLC/A2/C/2 precision scales

9. KEYS

	Press to switch the weighing device on/off – hold the key for about 1 second.
	Function key, press to change the working mode.
	Press to send the weighing result to a printer or computer.
	Press to zero the scale.

	Press to tare the scale.
	Press to perform internal adjustment manually (WLC/A1/C/2, WLC/A2/C/2 scales).

	<p>Upon pressing  +  keys combination, functions of given keys change. Detailed information concerning use of  +  keys combination is to be found further down this manual.</p>
---	---

10. PROGRAM STRUCTURE













Program menu is divided into function groups. Function group is a group of interrelated parameters.

10.1. Function Groups

Function group number	Function group name	Description
P1	CAL	User adjustment
P2	rEAd	Readout parameters
P3	Func	Working modes
P4	Conn	Communication
P5	ducE	Peripheral devices
P6	Prnt	Printouts
P7	Othr	Operation-related functions
P8	InFo	Scale data
P9	Unit	Units
IO	-	Inputs / Outputs
IE	-	Import / Export

10.2. Operating the Menu

In order to navigate the program menu use the operation panel.



 + 	Press to enter the main menu.
 + 	Press to: <ul style="list-style-type: none"> • enter tare manually. • enter tare from tare database, • change value by 1 digit up, • scroll the menu up.
 + 	Press to check battery/accumulator state.
 + 	Press to view date/time.
	Press to: <ul style="list-style-type: none"> • scroll the menu down, • change current parameter value.
	Press to: <ul style="list-style-type: none"> • enter given submenu, • modify given parameter.
	Press to confirm modification.
	Press to: <ul style="list-style-type: none"> • exit, function remains unmodified, • move one menu level up.

10.3. Return to the Weighing Mode

Introduced menu modifications are automatically saved to scale memory upon return to the home screen. To return to the home screen press  key repeatedly.

11. WEIGHING OPERATION

Load the weighing pan. Read the result when  stability marker is displayed.



	Only stable weighing results can be recorded (stability marker .
---	--

11.1. Good Weighing Practice

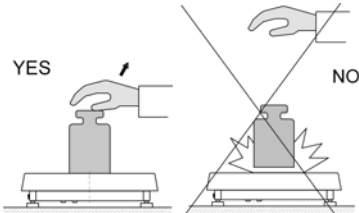
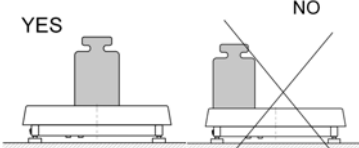
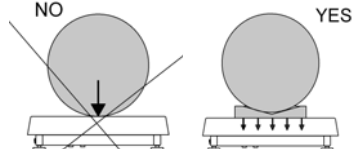
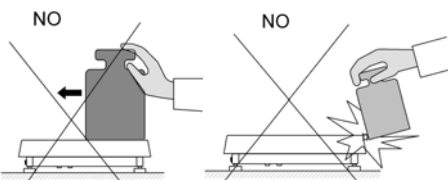
To assure long-term operation and correct mass measurements, follow the rules presented below:



<p>Load the weighing pan steadily avoiding mechanical shocks.</p>	
<p>Place weighed loads centrally on the weighing pan (eccentricity errors are specified by EN 45501 standard, point 3.6.2.).</p>	
<p>Do not apply concentrated force (total load in one point).</p>	
<p>Avoid side loading, in particular side shocks.</p>	

11.2. Zeroing

To zero mass indication press  key. Zero indication and the following pictograms are displayed:  and . The instrument can be zeroed only when the indication is stable.

	<p>Indication can be zeroed only within $\pm 2\%$ range of maximum capacity. If the zeroed value is greater than $\pm 2\%$ of the maximum capacity, then the software displays message <Err2>, and short sound signal is heard.</p>
---	--





11.3. Taring



To determine net weight value, load the weighing pan with a packaging, wait for a stable indication and press  key. Zero indication and the following pictograms are displayed: **Net** and . The weighing device has been tared. Upon loading, net mass is displayed.

Taring can be carried out repeatedly within the whole weighing range. Remember not to exceed the maximum capacity, i.e. sum of tare weight value and load weight value must be lower than the maximum capacity value. Upon unloading the weighing pan, the sum of tared masses with minus sign is displayed.

	<i>It is impossible to tare zero or negative values. When you tare zero or negative values, message <Err3> is displayed, short sound signal is heard.</i>
---	--

11.4. Entering Tare Value Manually

- Press  and  keys combination, tare value edit box is displayed.
- Enter tare value, to do it press  and  keys:

	Press to select digit that is to be edited.
	Press to set digit value, 0 - 9 .

- Press  key to confirm, the scale returns to the weighing mode, modified tare value with '-' sign is displayed.
- You can enter tare value at any time during the weighing operation.

11.5. Dual Range Devices

N/A in case of single range scales

Switching from weighing with the accuracy of the **I weighing range** to weighing with the accuracy of the **II weighing range** takes place automatically upon exceeding Max of the **I weighing range**. Upon switching to weighing with the accuracy of the **II weighing range**, respective pictogram/marker  is displayed in the top left hand corner.

To return to weighing with accuracy of the **I weighing range**:

- Take the load off the weighing pan.
- As the indication returns to zero and when symbols $\rightarrow 0 \leftarrow$ and $\blacktriangle \blacktriangle$ are displayed, press  button.
- If weighing range pictogram/marker gets blank, the scale returns to weighings with the accuracy of the I weighing range.

11.6. Units

<P9.Unit> parameter group enables change of start unit and temporary unit. Unit change can be performed in the course of weighing or during operation of other modes. 'Parts counting' and 'Percent weighing' modes are exceptions.

11.6.1. Start Unit

Parameter for setting unit that is displayed and used after device start-up.

Procedure:

- Enter **<P9.Unit / 9.1.UnSt>** submenu.
- Press  key, available units are displayed successively one by one.

Options in case when the main unit is [kg]:



- kg (kilogram),
- g (gram),
- lb (pound)*,
- N (Newton).

*) – unit disabled for verified weighing devices.

Options in case when the main unit is [g]:

- g (gram),
- kg (kilogram),
- ct (carat),
- lb (pound)*.

*) – unit disabled for verified weighing devices.

- Select start unit and press  key, next go back to the home screen, to do it press  key.
- Upon next start-up the scale runs with set start unit.

11.6.2. Temporary Unit

Temporary unit runs from the moment it is set to the scale shut-down and restart.

Procedure:

- Enter <P9.Unit / 9.2.Unin> submenu.
- Press  key, available units are displayed successively one by one.

Options in case when the main unit is [kg]:

- kg (kilogram),
- g (gram),
- lb (pound)*,
- N (Newton).

*) – unit disabled for verified weighing devices.

Options in case when the main unit is [g]:

- g (gram),
- kg (kilogram),
- ct (carat),
- lb (pound)*.

*) – unit disabled for verified weighing devices.

- Select temporary unit and press  key, next go back to the home screen.



12. ADJUSTMENT

In order to ensure the highest weighing accuracy, it is recommended to periodically introduce corrective factor of indications to scale memory, the said factor must be referred to a reference weight. This is so called adjustment. Adjustment has to be carried out:

- prior weighing,
- if long breaks between successive measuring series occur,
- if the ambient temperature has changed dynamically,
- if the scale has been relocated.

Adjustment types:

- external adjustment performed using an external weight of declared mass, i.e. mass that cannot be modified,
- user adjustment performed using an external weight of mass of any value comprised within the weighing range, however not lower than 30% of the maximum capacity value.
- automatic internal adjustment,
- manual internal adjustment.



	<p><i>In case of verified scales only two adjustment types are available: automatic internal adjustment and manual internal adjustment. Remember to carry out the adjustment process when there is no load on the pan! When the weighing pan is loaded with too heavy load, message <Err4> is displayed. In such case, unload the weighing pan and repeat the adjustment. Adjustment process can be aborted if necessary at any time, to do it press   key.</i></p>
--	---

12.1. External Adjustment

option available for non-verified scales exclusively

External adjustment must be carried out using an external adjustment weight of class F₁, adjustment weight mass is conditioned by scale type and maximum capacity.

Procedure:



- Enter **<P1.CAL / 1.1.CA-E>** submenu, text **<UnLoAd>** (remove weight) is displayed.
- Remove the load from the weighing pan and press  key.
- Mass of an empty weighing pan is determined, this is signalled with display of 'dash', **< - >**. Next, text **<LoAd>** (load weight) and mass value that is to be loaded, e.g. **2000 g** (conditioned by scale type), are displayed.
- Load the weighing pan with weight of specified mass value and press  key.
- Weight mass is determined, this is signalled with display of 'dash', **< - >**. Next, text **<UnLoAd>** (remove weight) is displayed.
- Remove the load from the weighing pan, **<1.1.CA-E>** submenu is displayed.

12.2. User Adjustment

option available for non-verified scales exclusively

External adjustment must be carried out using an external adjustment weight of class F₁, and of mass value $\geq 30\%$ of the maximum capacity value.

Procedure:

- Enter **<P1.CAL / 1.2.CA-u>** submenu, edit box for declaring weight mass is displayed (the mass value must be $\geq 30\%$ of the maximum capacity value).
- Enter weight mass value and press  key to confirm, text **<UnLoAd>** (remove weight) is displayed.
- Remove the load from the weighing pan and press  key.
- Mass of an empty weighing pan is determined, this is signalled with display of 'dash', **< - >**. Next, text **<LoAd>** (load weight) and mass value that is to be loaded, e.g. **2000g**, are displayed.
- Load the weighing pan with weight of specified mass value and press  key.
- Weight mass is determined, this is signalled with display of 'dash', **< - >**. Next, text **<UnLoAd>** (remove weight) is displayed.
- Remove the load from the weighing pan, **<1.2.CA-u>** submenu is displayed.

12.3. Manual Internal Adjustment

Manual internal adjustment is carried out using an in-built internal weight.



Adjustment requires stable ambient conditions (no air drafts, ground vibrations, etc.). Adjustment must be carried out when the weighing pan is unloaded.

Procedure:

- In the course of regular scale operation press  key, adjustment process is run automatically.
- Adjustment process, when in progress, is signalled with display of 'dash', **< - >**.
- Upon completed adjustment process, the scale automatically returns to the weighing mode.

12.4. Automatic Internal Adjustment

Automatic internal adjustment is triggered:

- after connection of the scale to the mains,
- when temperature variation occurs,
- after passage of specified time interval.

In case of an automatic internal adjustment it is necessary to declare condition that is to trigger the automatic adjustment. To declare the condition, go to **<1.5.ACL>** parameter:

nonE	Adjustment disabled.
tnnP	Adjustment triggered by temperature variation greater than 3°C.
tinnE	Adjustment carried out in specified time intervals. For non-verified scales it is possible to set the time interval between successive automatic adjustment processes (read section 12.5 of this manual). For verified scales the time interval is 12 hours.
bothH	Adjustment triggered by both time and temperature.

Adjustment upon connection of the scale to the mains

- Upon completed start-up procedure, scale stability conditions regarding adjustment are checked, the internal adjustment is triggered automatically.
- Adjustment process, when in progress, is signalled with display of 'dash', < - >.
- Upon completed adjustment process, the scale automatically returns to the weighing mode.

Adjustment upon temperature change

- The scale is equipped with precise system monitoring temperature variation and registering temperature value for each completed adjustment process.
- Adjustment process is triggered automatically at the moment when temperature measured by the scale changes by more than 3°C.
- Right before the adjustment process, scale stability conditions are checked.
- Adjustment process, when in progress, is signalled with display of 'dash', < - >.
- Upon completed adjustment process, the scale automatically returns to the weighing mode.

Adjustment upon passage of specified time interval

- The scale is equipped with RTC, due to this time of each completed process is registered.
- Adjustment process is triggered automatically after passage of particular time interval, set in **<1.6.CAC>** parameter.
- Adjustment process, when in progress, is signalled with display of 'dash', **< - >**.
- Upon completed adjustment process, the scale automatically returns to the weighing mode.

12.5. Automatic Internal Adjustment Time

option available for non-verified scales exclusively

Parameter determining time interval between successive automatic internal adjustments. The time interval is declared in hours and ranges between **0.5 [h]** and **12 [h]**.

Procedure:

- Enter **<P1.CAL / 1.6.CAC>** submenu.
- Press  key, available values, given in hours, are displayed successively one by one:

Available values: 05 H, 1 H, 2 H, 3 H, 4 H, 5 H, 6 H, 7 H, 8 H, 9 H, 10 H, 11 H, 12 H.

12.6. Adjustment Test

Adjustment test function enables comparison of the internal adjustment results with the value recorded in factory parameters. Such comparison is used for determining drift of scale sensitivity over time.

Procedure:

- Enter **<P1.CAL / 1.4.AtS>** submenu, internal adjustment process starts automatically.
- Adjustment process, when in progress, is signalled with display of **<CAL>** text.
- Upon completed adjustment process, **<1.4.CAtS>** parameter is displayed automatically.

12.7. Adjustment Report

Adjustment report, and adjustment test report are both automatically printed (using scale-connected printer) at the end of each adjustment process. To declare report content go to **<P6.1.CrEP>** submenu. For detailed information concerning report content read later sections of this manual.

13. SCALE PARAMETERS

Scale parameters are set to adjust the weighing device to ambient conditions (filters) or individual needs (autozero on/off, tare values memory). These parameters are to be found in **<P2.rEAd>** submenu. **<P2.rEAd>** submenu comprises functions allowing you to adjust your weighing device to ambient conditions of given workstation.

13.1. Filter

- Enter **<P2.rEAd / 2.1.FiL>** submenu.

- Press  key, filter values are displayed successively one by one: **1** - Fast, **2** - Average, **3** – Slow.

- Set respective value and press  key to confirm, next go to the home screen.



The higher filter value, the longer the weighing takes.

13.2. Value Release

Enter this parameter to adjust rate of stabilisation of the measurement result. Depending on the selected option, weighing time is either shorter or longer.

Procedure:

- Enter **<P2.rEAd / 2.2.APPr>** submenu.



- Press  key, available values are displayed successively one by one: **F_P** - fast and reliable, **PrEc** – reliable, **FASt** – fast.

- Press  key to confirm, next go to the home screen.

13.3. Ambient Conditions

Parameter relating to ambient and environmental conditions of the workstation. Enter this parameter and set 'nStAb' value if the ambient conditions are unfavourable (air drafts, vibrations).

Procedure:



- Enter **<P2.rEAd / 2.3.Enut>** submenu.
- Press  key, parameter values are displayed successively one by one: **nStAb** – unstable, **StAb** – stable.
- Press  key to confirm, next go to the home screen.

13.4. Autozero Function

'Autozero' function has been designed to enable automatic control and correction of zero indication. This guarantees precise weighing results.

There are, however, some cases when this function can be a disturbing factor for the measuring process, e.g. very slow placing of a load on the weighing pan (load adding, e.g. pouring, filling). In such case, it is recommended to disable the function.

Procedure:

- Enter **<P2.rEAd / 2.4.Aut>** submenu.
- Press  key, parameter values are displayed successively one by one: **YES** – autozero function enabled, **no** – autozero function disabled.
- Press  key to confirm, next go to the home screen.

13.5. Tare Function

'Tare' function has been designed to enable setup of appropriate parameters for tare operation.

Procedure:

- Enter **<P2.rEAd / 2.5.tArE>** submenu.
- Press  key, available values are displayed successively one by one:

no	Regular tare mode. Select this parameter to make the scale overwrite the set (selected) tare value with the most recently entered one.
tArF	Select this parameter to make the scale store the latest tare value in memory. The latest tare value is displayed after scale restart.
AtAr	Automatic tare mode.
EAcH	Select this parameter to make the scale automatically tare each accepted measurement.





- Press  key to confirm, next go to the home screen.

13.6. Tare: Enter Mode

The tare is entered using  +  keys combination from the home screen level. There are two enter modes.

Procedure:

- Enter **<P2.rEAd / 2.6.ttr>** submenu.
- Press  key, parameter values are displayed successively one by one:

tArEH	Select to enter tare value manually by means of  +  keys combination.
tArnn	Select to enter tare value that is stored in scale memory, use  +  keys combination.



- Press  key to confirm, next go to the home screen.



13.7. Tare: Values Memory



It is possible to store 10 tare values in scale memory.

13.7.1. Entering Tare Value to the Weighing Device Memory



- Enter **<P2.rEAd / 2.7.tArn>** submenu, name of tare no. 1 from tares database is displayed (**<tArE 0>**), to select a different record press  key.

- Select respective entry and press  key, tare value edit box is displayed.
- Enter tare value, to do it press  and  keys:

	Press to select digit that is to be edited.
	Press to set digit value, 0 - 9 .

- Press  key to confirm, **<tArE 0>** window is displayed.
- Now press  key to go to the home screen.

13.7.2. Selecting Tare Value from the Weighing Device Memory

- Enter **<P2.rEAd / 2.7.tArn>** submenu, name of tare no. 1 from tares database is displayed (**<tArE 0>**), to select a different record press  key.
- To set the selected tare press  key.
- The set tare value is displayed with minus sign, **Net** symbol is shown in the upper-left corner of the screen:

	<i>The tare value acquired from the weighing device memory is not remembered upon the weighing device restart.</i>
--	---

13.8. Last Digit

Function designed to disable display of the last weighing indication digit, this results with less accurate measurement.

Procedure:

- Enter **<P2.rEAd / 2.8.LdiG>** submenu.
- Press  key, available values are displayed successively one by one:

ALAS	Select to make the last digit always on.
nEur	Select to make the last digit always off.

uuSt	Select to make the last digit on only when the weighing indication is stable.
-------------	---



- Press  key to confirm, next go to the home screen.

14. COMMUNICATION

Communication between the scale and the peripheral devices is established via the following ports: RS232 (1), RS232 (2), USB type A, USB type B. To set the ports go to < **P4.Conn** > submenu.

14.1. RS232 (1) Port Settings

- Enter < **P4.Conn / 4.1.rS1** > submenu and set respective transmission parameters:

4.1.1.bAd	Baud rate: 2400, 4800, 9600, 19200, 38400, 57600, 115200 bit/s.
4.1.2.PAr	Parity: nonE – none; EuEn – even; Odd – odd.



- Press  key to confirm, next go to the home screen.

14.2. RS232 (2) Port Settings

- Enter < **P4.Conn / 4.2.rS2** > submenu and set respective transmission parameters:

4.2.1.bAd	Baud rate: 2400, 4800, 9600, 19200, 38400, 57600, 115200 bit/s.
4.2.2.PAr	Parity: nonE – none; EuEn – even; Odd – odd.



- Press  key to confirm, next go to the home screen.

14.3. USB A Port

USB port of type A is intended for:

- Connecting a USB flash drive in order to enable:
 - operator's parameters export/import,
 - weighing reports export,
 - Alibi reports export.
- Connecting scale to PCL printer.
- Connecting EPSON TM-T20 printer (featuring USB port).





The USB flash drive must support FAT files system.

14.4. USB B Port

USB port of type B is intended for connecting the scale to a computer. In order to make connection of scale and computer possible, it is necessary to install virtual COM port in a computer. To carry out this procedure, you need a respective driver installer which may be either downloaded from www.radwag.pl website or taken from a CD with manuals: **RADWAG USB DRIVER x.x.x.exe**.

Procedure:

1. Run the driver installer and follow the commands.

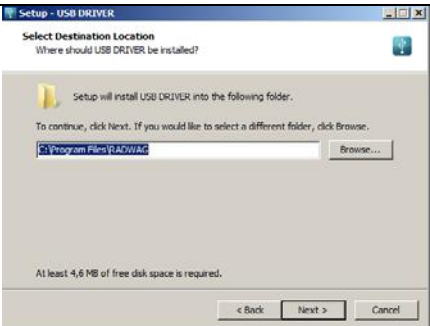
	<p>Select language version and press „OK” button for confirmation.</p>
	<p>In order to continue press „Next” button.</p>
	<p>Select directory and press „Next” button.</p>

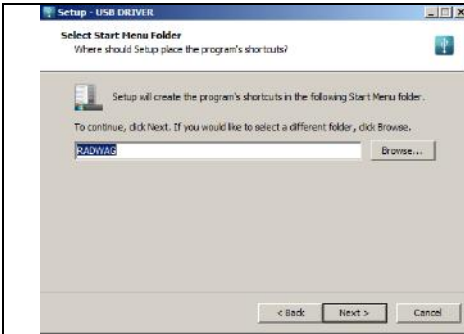

In order to start installation process press „**Next**” button.

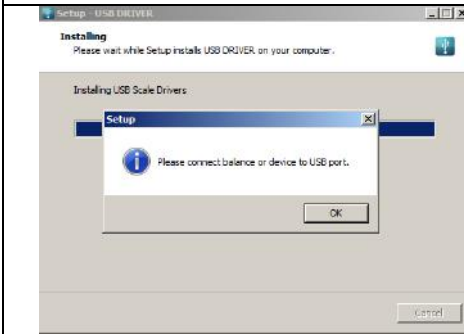

Connect the scale to a computer, use 1.8-meter long USB A/B cable maximum (in case of already connected scale, it is necessary to disconnect it and reconnect using USB cable). Respective message box is displayed, press **OK** button for confirmation.



Press „**Finish**” button.

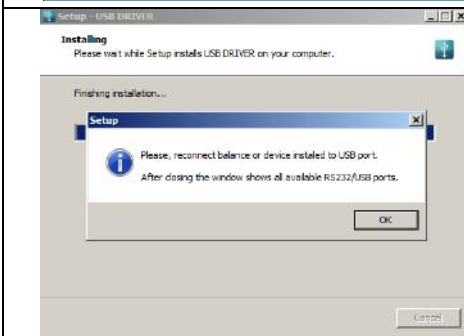

Connect the scale to a computer again, use 1.8-meter long USB A/B cable maximum. Respective message box is displayed, press **OK** button for confirmation.

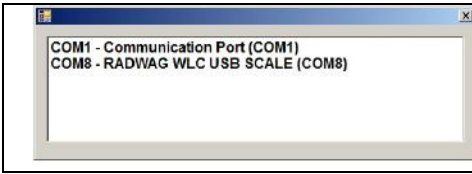

„**COM ports Screen**” automatically displays number of installed COM port. In this very case it is COM8.

2. Enter < **P5.ducE / 5.1.PC / 5.1.1.Prt**> submenu and set <**USbb**> value.
3. Run program for measurements readout.
4. Set communication parameters – select COM port that was installed in the course of drivers installation (in this very case it is COM8).
5. Start cooperation.

15. PERIPHERAL DEVICES



<**P5.ducE**> menu contains list of devices cooperating with scale.

15.1. Computer

<**5.1.PC**> submenu allows you to:

- select port to which the computer is connected,
- enable/disable continuous transmission,
- set frequency of printouts for continuous transmission.

15.1.1. Computer Port

- Enter <**5.1.PC / 5.1.1.Prt**> submenu.
- Press  key, parameter values are displayed successively one by one: **nonE** – none; **rS1** – RS232 (1); **rS2** – RS232 (2), **USbb** – USB type B.
- Press  key to confirm, next go to the home screen.

15.1.2. Continuous Transmission

- Enter <**5.1.PC / 5.1.2.Cnt**> submenu.
- Press  key, parameter values are displayed successively one by one:

nonE	Continuous transmission disabled.
CntA	Continuous transmission in basic unit.
Cntb	Continuous transmission in current/temporary unit.

- Press  key to confirm, next go to the home screen.

15.1.3. Printout Interval for Continuous Transmission

Parameter enabling you to set frequency of printout for continuous transmission. Printout interval is set in seconds with 0.1 [s] accuracy within 0.1 [s] - 3600 [s] range.

Procedure:

- Enter **<5.1.PC / 5.1.3.Int>** submenu, window for entering interval value is displayed.
- Press  key to confirm, next go to the home screen.

15.2. Printer

15.2.1. Printer Port

Parameter enabling you to select port to which data is to be sent upon pressing



key.

Procedure:

- Enter **<5.2.Prtr / 5.2.1.Prt>** submenu.
- Press  key, parameter values are displayed successively one by one:



nonE	None port selected.
rS1	Port RS232 (1).
rS2	Port RS232 (2).
USbA	USB port of type A, to which printer can be connected.
USbb	USB port of type A, to which computer can be connected.

- Press  key to confirm, next go to the home screen.

15.3. Additional Display

The weighing instrument can cooperate with additional WD displays.

15.3.1. Additional Display Port

- Enter <5.3.AdSP / 5.3.1.Prt> submenu.
- Press  key, parameter values are displayed successively one by one: **nonE** – none; **rS1** – RS232 (1); **rS2** – RS232 (2).
- Press  key to confirm, next go to the home screen.

16. PRINTOUTS

It is possible to define adjustment report printout template and GLP printout template. To set the printouts go to < P6.Prt > submenu.

16.1. Adjustment Report

<P6.1.CrEP> is a group of parameters allowing you to declare variables that are to be printed on an adjustment report printout. Each variable features accessibility attribute: **YES** – print, **no** – do not print. Adjustment report is automatically generated upon each completed adjustment process.

Variables list:

No.	Name	Description
6.1.1.	CtP	Performed adjustment type.
6.1.2.	dAt	Adjustment date.
6.1.3.	tin	Adjustment time.
6.1.4.	ldb	Serial number of the scale.
6.1.5.	CdF	Difference between mass of adjustment weight that was measured during last adjustment and mass of currently measured adjustment weight.
6.1.6.	dSh	Dashed line separating printout data and signature fields.
6.1.7.	SiG	An area for the signature of an operator carrying out the adjustment.



Printouts are generated exclusively in English.

Report example:

```

-----Calibration Report-----
Calibration type           External
Date                       2016.10.15
Time                       12:39:23
Balance ID                 123456
Difference                  -0.02g
-----
Signature
.....
    
```

16.2. GLP Printout

<P6.2.GLP> is a group of parameters allowing you to declare variables that are to be printed on a weighing printout. Each variable features accessibility attribute: **YES** – print, **no** – do not print.

Variables list:

No.	Name	Description
6.2.1.	dAt	Performed weighing date.
6.2.2.	tin	Performed weighing time.
6.2.3.	n	Net weight value of performed weighing in basic measuring unit.
6.2.4.	t	Tare weight value in the current unit.
6.2.5.	b	Gross weight value in the current unit.
6.2.6.	CrS	Current weighing result (net weight) in a current unit.
6.2.7.	CrP	The last adjustment report generated in accordance with settings declared for the adjustment report printout.

	<p><i>Printouts are generated exclusively in English.</i></p>
---	--

Report example:

```

Date           2016.10.15
Time           12:04:17
Net            49.98g
Tare           17.20g
Gross          67.18g
    
```

17. MISCELLANEOUS PARAMETERS

<**P7.Othr**> is a group of parameters enabling you to adapt the scale to individual needs.

17.1. Backlight

Parameter allowing you to change display brightness, the brightness can be changed within **0% - 100%** range.

Procedure:

- Enter <**P7.Othr / 7.1.bLbt**> submenu.
- Press  key, parameter values are displayed successively one by one, where:



nonE	Backlight off.
10	Display brightness low limit value in [%].
100	Display brightness high limit value in [%].

- Press  key to confirm, next go to the home screen.

17.2. 'Beep' Sound

Parameter allowing you to enable/disable sound signal informing the operator about pressing panel key(s).

Procedure:



- Enter <**P7.Othr / 7.2.bBEEP**> submenu.
- Press  key, parameter values are displayed successively one by one: **no** – sound signal disabled, **YES** - sound signal enabled.
- Press  key to confirm, next go to the home screen.

17.3. Automatic Shutdown

Parameter allowing you to set time interval, in [min], after which the weighing device shuts down automatically. If the indication is stable during the declared time interval, the device is shut down automatically.

Shutdown function is inactive and the device cannot be turned off if any process is started or if you operate the menu.

Procedure:

- Enter **<P7.Othr / 7.3.t1>** submenu.
- Press  key, parameter values are displayed successively one by one: **nonE** – function disabled, **1, 2, 3, 5, 10**.
- Press  key to confirm, next go to the home screen.

17.4. Date and Time

Parameter allowing you to set current date and time and to specify date and time format.

Procedure:

- Enter **<P7.Othr>** submenu and change the settings. Refer to the below table:

Parameter	Description
<7.4.SdAt>	Enter this parameter to set current date, where the date format is YYYY.MM.DD* .
<7.5.Stnn>	Enter this parameter to set current time, where the time format is 24H** .
<7.6.FdAt>	Enter this parameter to select date format. Available values: 1 - DD.MM.YYYY, 2 - MM.DD.YYYY, 3 - YYYY.MM.DD* (set by default), 4 - YYYY.DD.MM.
<7.7.Ftin>	Enter this parameter to select time format. Available values: 24H** (set by default), 12H** .

**) - Date format: Y – year, M – month, D – day.*

****) - Time format: 12H – 12-hour format, 24H - 24-hour format.*

17.5. Default User Settings

Parameter allowing you to restore default operator settings.

Procedure:

- Enter **<P7.Othr / 7.8.dFLu>** submenu, text **<Cont?>** is displayed (Continue?).



- Press  key to confirm. The process of restoring default settings starts, this is signalled with display of 'dash', < - >.
- Upon process completion <7.8.dFLu> submenu is displayed. Go to home screen.

18. SCALE DATA

Scale data menu, <P8.InFo>, provides information on the weighing device and its program. The parameters serve informative purposes:



Parameter	Description
<8.1.Idb>	Serial number of the scale.
<8.2.PurS>	Program version.
<8.4.PStP>	Settings printout. Enter the parameter to send scale settings to printer port (all parameters).

19. WORKING MODES – General Information

The weighing device features the following working modes:

- Weighing,
- Parts counting,
- +/- control,
- Percent weighing %,
- Peak Hold,
- Totalizing,
- Animal weighing.

19.1. Running Working Mode

- Go to home screen, press  key, name of the first available working mode is displayed.
- Press  key, names of available working modes are displayed successively one by one.
- Enter selected working mode, to do it press  key.



The weighing device program has been designed to make the scale run, upon restart, with the latest operated working mode on.

19.2. Working Modes Local Settings

Each working mode features specific (local) functions which enable adapting device operation to individual needs. The functions are to be found in local settings. To go to local settings of each working mode enter **<P3.Func>** submenu. Some special functions are available for all working modes, refer to the table below:



	Accessibility	Save mode	Time interval	Lo threshold
Weighing	3.1.1.Acc	3.1.2.Snn	3.1.3.Int	3.1.4.Lo
Parts counting	3.2.1.Acc	3.2.3.Snn	3.2.4.Int	3.2.5.Lo
+/- control	3.3.1.Acc	3.3.2.Snn	3.3.3.Int	3.3.4.Lo
Percent weighing %	3.4.1.Acc	3.4.3.Snn	3.4.4.Int	3.4.5.Lo
Peak Hold	3.5.1.Acc	-	-	3.5.2.Lo
Totalizing	3.6.1.Acc	3.6.2.Snn	3.6.3.Int	3.6.4.Lo
Animal weighing	3.7.1.Acc	-	-	3.7.3.Lo

The table presents special function number and name for each of the working modes. Remaining specific functions referring directly to a given working mode are described further down this user manual.

19.2.1. Working Mode Accessibility

To enable/disable given working mode, press  key.

Procedure:

- Enter **<P3.Func>** menu and select given working mode.
- Go to **<Acc>** function.
- Press  key, parameter values are displayed successively one by one: **YES** – working mode enabled, **no** – working mode disabled.
- Press  key to confirm, next go to the home screen.



19.2.2. Save Mode

Parameter allowing you to set mode of sending data from the weighing device to a peripheral device.

Procedure:

- Enter **<P3.Func>** menu and select given working mode.
- Go to **<Snn>** function.

- Press  key, parameter values are displayed successively one by one:

StAb	Manual printout of stable weighing result. Upon pressing  key at the moment when the result is unstable (no  pictogram displayed), the program first waits for the stability condition to be met, only then printout is carried out.
nStAb	Manual printout of each weighing result. In case of unstable indication, <?> sign is displayed in front of the 'mass frame'. Function available for non-verified scales exclusively.
rEPL	Automatic printout of the first stable weighing result above <Lo> threshold (to set <Lo> threshold go to <Lo> parameter).
rEPLi	Automatic printout with time interval set in [min] (to set the interval go to <Int> parameter).

- Press  key to confirm, next go to the home screen.

19.2.3. Automatic Printout Time Interval

Parameter enabling you to set frequency of automatic printout. Printout interval is set in minutes with 1 [min] accuracy within 1 [min] - 1440 [min] range.

Procedure:

- Enter **<P3.Func>** menu and select given working mode.
- Enter **<Int>** function, window for entering **time interval** value is displayed.
- Press  key to confirm, next go to the home screen.

19.2.4. Lo Threshold

<Lo> parameter allows you to configure the function of automatic operation. In order to save the next measurement, before carrying it out the mass indication must get below the set net value of Lo threshold.

Procedure:

- Enter **<P3.Func>** menu and select given working mode.
- Enter **<Lo>** function, window for entering **Lo threshold** value is displayed.
- Enter respective value and press  key to confirm, then continue weighing.

20. WORKING MODE – WEIGHING

<UUGG> is a standard working mode enabling you to carry out the weighing operation along with record of the result to the database.

20.1. Local Settings

To go to local settings enter <3.1.UUGG> submenu.

3.1.1.Acc	Working mode accessibility	For detailed description read section 19.2.1.
3.1.2.Snn	Save mode	For detailed description read section 19.2.2.
3.1.3.Int	Time interval	For detailed description read section 19.2.3.
3.1.4.Lo	Lo threshold	For detailed description read section 19.2.4.

21. WORKING MODE – PARTS COUNTING

Parts Counting is a working mode enabling you to determine quantity of small pieces of the same mass, which determination is done on the basis of mass of sample piece (single part), and where the sample piece mass (single part mass) is determined using the weighing device.

21.1. Local Settings

To go to local settings enter <3.2.PcS> submenu.

3.2.1.Acc	Working mode accessibility	For detailed description read section 19.2.1.
3.2.2.UUt	Operation mode	For detailed description read section 21.1.1.
3.2.3.Snn	Save mode	For detailed description read section 19.2.2.
3.2.4.Int	Time interval	For detailed description read section 19.2.3.
3.2.5.Lo	Lo threshold	For detailed description read section 19.2.4.

21.1.1. Selecting Operation Mode

Parameter allowing you to select method of determination of sample piece mass.

Procedure:

- Enter <3.2.PcS / 3.2.2.UUt> submenu.





- Press  key, parameter values are displayed successively one by one:

S_S	Select to set sample mass by determining mass of a single part.
Suu	Select to set sample mass by entering mass of a single part.

- Enter respective value and press  key to confirm, then continue weighing.

21.2. Setting Sample Mass by Entering Mass of a Single Part

- Enter **<3.2.PcS / 3.2.2.UUt>** submenu, set **<Suu>** value.
- Enter **<PcS>** working mode (parts counting), first, text **<SEt_Ut>** is displayed for 1 s, next, window for entering mass value of a single part.
- Enter respective value and press  key to confirm, home screen is displayed automatically along with quantity of parts loaded onto the weighing pan (pcs).



	<i>If the value of entered single part mass is greater than max capacity value, then message <Err Hi> is displayed.</i>
---	--





21.3. Setting Sample Mass by Determining Mass of a Single Part

- Enter **<3.2.PcS / 3.2.2.UUt>** submenu, set **<S_S>** value.
- Enter **<PcS>** working mode (parts counting), blinking value of sample quantity is displayed.
- Press  key to select one of the following options:

10	Reference sample quantity: 10 pcs.
20	Reference sample quantity: 20 pcs.
50	Reference sample quantity: 50 pcs.
100	Reference sample quantity: 100 pcs.
0000	Custom reference sample quantity - enter the required value yourself.

- Select respective option and press  key to confirm, first, text **<LoAd>** is displayed for 1 second, then the weighing window.
- If the parts are to be weighed in a container, first put the container on a weighing pan and tare it.

- Load the weighing pan with declared amount of parts. When the indication is stable ( pictogram is displayed), press  key to confirm the mass.
- Single part mass is calculated automatically, next quantity of parts (pcs) is displayed.

	Total weight value of all parts loaded onto the weighing pan cannot be greater than the max capacity value.
	Single part mass value must be equal or greater than 0.1 of the reading unit. Unless this condition is met, the weighing device displays a message <Err Lo>.
	In the course of parts quantity determination before confirming the declared quantity value it is necessary to wait for a stable measurement, .

22. WORKING MODE – +/- CONTROL



+/- control is a working mode enabling you to enter checkweighing thresholds values (**Min, Max**).

22.1. Local Settings



To go to local settings enter <3.3.HiLo> submenu.

3.3.1.Acc	Working mode accessibility	For detailed description read section 19.2.1.
3.3.2.Snn	Save mode	For detailed description read section 19.2.2.
3.3.3.Int	Time interval	For detailed description read section 19.2.3.
3.3.4.Lo	Lo threshold	For detailed description read section 19.2.4.

22.2. Declaring Checkweighing Thresholds

- Enter <HiLo> working mode (+/- control), first, text <SEt Lo> is displayed for 1 s, next, window for declaring low weighing threshold (Min).
- Enter respective value and press  key to confirm, first, text <SEt Hi> is displayed for 1 second, next, window for declaring high weighing threshold (Max).
- Enter respective value and press  key for confirmation, working mode's home screen is displayed along with declared threshold value, where:

Min	Load mass lower than low weighing threshold.
Ok	Load mass within weighing thresholds.
Max	Load mass greater than high weighing threshold.

	<i>If the entered low threshold value (Min) is greater than high threshold value (Max), <Err Lo> error is displayed.</i>
	<i>If the entered high threshold value (Max) is greater than the maximum capacity value, <Err Hi> error is displayed.</i>

23. WORKING MODE – PERCENT WEIGHING

Percent weighing is a working mode enabling you to compare measured load mass with the reference sample mass. The result is expressed in [%]. Reference sample mass can be either determined by weighing or entered to weighing device memory by an operator.

23.1. Local Settings

To go to local settings enter <3.4.dEu> submenu.

3.4.1.Acc	Working mode accessibility	For detailed description read section 19.2.1.
3.4.2.UUt	Operation mode	For detailed description read section 23.1.1.
3.4.3.Snn	Save mode	For detailed description read section 19.2.2.
3.4.4.Int	Time interval	For detailed description read section 19.2.3.
3.4.5.Lo	Lo threshold	For detailed description read section 19.2.4.

23.1.1. Selecting Operation Mode

Parameter allowing you to select method of determination of reference sample mass.



Procedure:

- Enter <3.4.dEu / 3.4.2.UUt> submenu.
- Press  key, parameter values are displayed successively one by one:

S_S	Select to set reference sample mass by determining the mass value.
Suu	Select to set reference sample mass by entering the mass value.

- Set respective value and press  key to confirm, next go to the home screen.

23.2. Reference Sample Mass Determined by Weighing

- Enter <3.4.dEu / 3.4.2.UUt> submenu, set <S_S> value.
- Enter <dEu> working mode (Percent weighing), first, text <LoAd> is displayed for 1 second, then the weighing window.
- Load the weighing pan with the reference sample. When the indication is stable ( pictogram is displayed), press  key to confirm the mass.
- Mass of the weighed load is automatically set as reference sample mass, the home screen is displayed along with **100.000%** value.

23.3. Reference Sample Mass Determined by Entering the Mass Value

- Enter <3.4.dEu / 3.4.2.UUt> submenu, set <Suu> value.
- Enter <dEu> working mode (Percent weighing).
- Text <SEt_Ut> is displayed for 1 s, next, window for declaring mass of reference sample.
- Enter respective value and press  key to confirm. The home screen is displayed automatically with **0.000%** value.

	<i>If the value of entered reference sample mass is greater than max capacity value, then message <Err Hi> is displayed.</i>
---	---

24. WORKING MODE – PEAK HOLD

Peak Hold is a working mode allowing you to snap value of maximum force applied to the weighing pan during one weighing process.

24.1. Local Settings

To go to local settings enter <3.5.toP> submenu.

3.5.1.Acc	Working mode accessibility	For detailed description read section 19.2.1.
3.5.2.Lo	Lo threshold	For detailed description read section 19.2.4.

24.2. Peak Hold Operation

- Enter **<3.5.toP / 3.5.2.Lo>** submenu, set **<Lo>** parameter value (Lo threshold) after exceeding of which maximum force is to be registered.
- Enter **<toP>** working mode (Peak Hold). From now on the scale registers and holds every single weighing which is above the **Lo threshold**, and which is higher than the result of the previous peak hold. Snapped peak hold value is signalled by **<Max>** pictogram displayed at the top of the screen.
- The start of the next process of peak hold measurement is possible only after removing the load from the weighing pan and pressing  key.
- This causes returning to the home screen of **<toP>** mode. Pictogram **<Max>** is automatically deleted.

25. WORKING MODE – TOTALIZING



Totalizing is a working mode enabling you to sum mass of all weighed ingredients, and to print (via scale-connected printer) the total mass value. The program allows you to sum up to 30 weighings (ingredients) maximum within one process.



25.1. Local Settings

To go to local settings enter **<3.6.Add>** submenu.

3.6.1.Acc	Working mode accessibility	For detailed description read section 19.2.1.
3.6.2.Snn	Save mode	For detailed description read section 19.2.2.
3.6.3.Int	Time interval	For detailed description read section 19.2.3.
3.6.4.Lo	Lo threshold	For detailed description read section 19.2.4.

25.2. Totalizing Operation



- Enter **<Add>** working mode (Totalizing), blinking „▲” pictogram is displayed.
- If the ingredients are to be weighed in a container, first put the container on a weighing pan and tare it.
- Load the weighing pan with the ingredient no.1. When the indication is stable ( pictogram is displayed), press  key to confirm the mass.
- Total mass value is displayed, now the „▲” pictogram is displayed continuously.

- Unload the weighing pan, **ZERO** is displayed, „▲” marker starts blinking again.
- Load the weighing pan with the ingredient no.2, wait for a stable weighing result and press  key.
- Total mass value of ingredient no. 1 and 2 is displayed, now the „▲” pictogram is displayed continuously.
- In order to finish the process, press  key, text <Prnt?> (Print?) is displayed.
- Press  key, total mass value of all recorded weighings is printed on a scale-connected printer.

Report example:

(1)	13.500 g
(2)	14.400 g
(3)	9.700 g
(4)	100.500 g
(5)	4.000 g
(6)	8.200 g
(7)	20.800 g
(8)	5.800 g

Total:	176.900 g

- In order to print the report once again press  key.
- To exit "report printout mode" press  key. As a result home screen of <Add> working mode is displayed and all the data get zeroed automatically.

	<p><i>If the display capacity is exceeded (i.e. there is not enough space for all the digits of the weighing result) <Hi> error is displayed. In such a case either remove the ingredient from a weighing pan and finish the totalizing process or place load of a lower weight value on the weighing pan.</i></p>
---	---

26. WORKING MODE – ANIMAL WEIGHING





Animal Weighing is a working mode enabling you to weigh products that disrupt efficient establishing of stability. It is mostly intended to measure weight of animals.

26.1. Local Settings

To go to local settings enter **<3.7.AnLS>** submenu.

3.7.1.Acc	Working mode accessibility	For detailed description read section 19.2.1.
3.7.2.Aut	Averaging time	Enter this parameter to declare duration of the process in seconds (5s, 10s, 20s, 30s, 40s, 50s, 60s) - on the basis of indications recorded within the set time interval the scale calculates the weighing result, i.e. an average weight value.
3.7.3.Lo	Lo threshold	For detailed description read section 19.2.4.

26.2. Animal Weighing Operation

- Enter **<AnLS>** working mode (Animal Weighing).
- First text **<tinnE>** is displayed for 1 s, next, window for setting duration (in seconds) of animal weighing.
- Press  key, parameter values are displayed successively one by one: 5[s], 10[s], 20[s], 30[s], 40[s], 50[s], 60[s].
- Set the respective value, press  key to confirm, weighing window with **A** letter is displayed.
- Load the weighing pan with an animal.
- On exceeding the set mass value of **<Lo> threshold** parameter, animal weighing starts, this is signalled with display of 'dash', **< - >**.
- Upon process completion mass value of an animal is snapped and displayed together with **OK** pictogram in the upper part of the display. The snapped mass value is sent to a scale-connected printer.
- Press  key to restart animal weighing.
- Press  key to reprint the snapped mass value.
- Upon unloading of the weighing platform, the weighing window with letter **A** is displayed. The scale can be loaded with an animal again.

27. IMPORT / EXPORT

Function enabling you to archive weighing reports and Alibi reports, and to copy parameters between weighing devices of the same series. Import/export operation can be carried out by means of USB flash drive comprising **<FAT files system>**. Upon connection of the USB flash drive to the USB A port, the drive gets detected automatically, as a result **<IE>** submenu is created.

Since extensions of exported weighing reports and Alibi reports files are specific, and the file-stored data is encoded, therefore the files content is not readable for standard computer programs. These files can be read using **ALIBI Reader**, PC software designed by RADWAG. You can download the software from RADWAG website: www.radwag.pl.

27.1. Weighing Records Export

Option enabling you to export weighings to a USB flash drive. Weighing device program offers option of record of 5000 weighings.

Procedure:

- Connect the USB flash drive to USB A port.
- Enter **<IE / IE1.UUE>** submenu.
- The program automatically saves exported data to a USB flash drive file.

File name and extension: xxxxxx.wei, where xxxxxx – serial number.

27.2. ALIBI Weighings Export

Option enabling you to export ALIBI weighings to a USB flash drive. Weighing device program offers option of record of 100 000 weighings.

Procedure:

- Connect the USB flash drive to USB A port.
- Enter **<IE / IE2.ALE>** submenu.
- The program automatically saves exported data to a USB flash drive file.

File name and extension: xxxxxx.ali, where xxxxxx – serial number.

27.3. Parameters Export / Import

Export / import of all user parameters between weighing devices of the same series carried out using USB flash drive.

Export procedure:

- Connect the USB flash drive to USB A port.
- Enter **<IE / IE3.SPE>** submenu.
- The program automatically saves exported data to a USB flash drive file.

File name and extension: xxxxxx.par, where xxxxxx – serial number.

Import procedure:

- Connect the USB flash drive to USB A port, make sure that the drive stores parameters file in the main directory (file name: **xxxxxx.par**, where xxxxxx – serial number).
- Enter **<IE / IE4.SPI>** submenu.
- User parameters are automatically imported from **xxxxxx.par** file.

28. INPUTS / OUTPUTS

WLC/A2 series scale is optionally equipped with 4 inputs and 4 outputs.

28.1. Inputs / Outputs Parameters

Inputs parameters	
Inputs quantity	4
Inputs type	Optoisolated
Input voltage range	5-24 V ± 10 %
Minimum input current	5 mA
Outputs parameters	
Outputs quantity	4
Outputs type	Solid-state relay
Polarization	bidirectional
Power supply type	AC or DC
Maximum output current	500 mA
Maximum output voltage	30 V

28.2. Inputs Setup

- Enter **<IO / In>** submenu and edit given input.
- Press  key, available values are displayed successively one by one:

no	Input inactive.
1	Change unit.
2	Zero.
3	Tare.
4	Print.
5	Internal adjustment (function enabled in WLC/A1/C/2, WLC/A2/C/2 scales exclusively).

- Press  key to confirm, next go to the home screen.

	<i>By default all inputs' functions are set to <no> value.</i>
---	---

28.3. Outputs Setup

- Enter **<IO / Out>** submenu and edit given output.
- Press  key, available values are displayed successively one by one:

no	Output inactive.
1	Stable.
2	MIN stable.
3	MIN unstable.
4	OK stable.
5	OK unstable.
6	MAX stable.
7	MAX unstable.
8	Zero.
9	!OK stable.
10	!OK unstable.
11	MIN threshold.
12	OK threshold.
13	MAX threshold.

- Press  key to confirm, next go to the home screen.

	<i>By default all outputs' functions are set to <no> value.</i>
---	--

29. DIAGRAMS OF CONNECTION CABLES

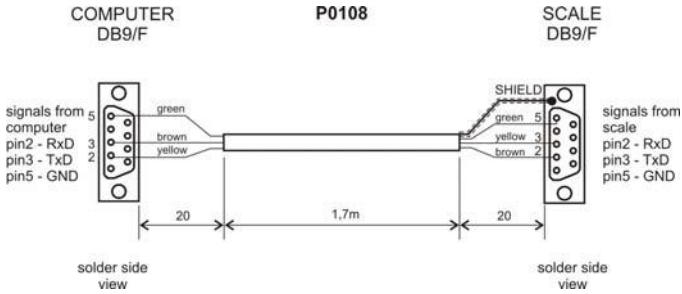

scale – computer cable

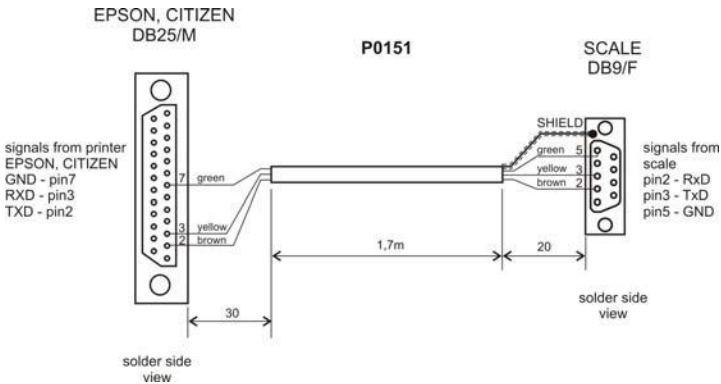

scale - printer cable (EPSON)

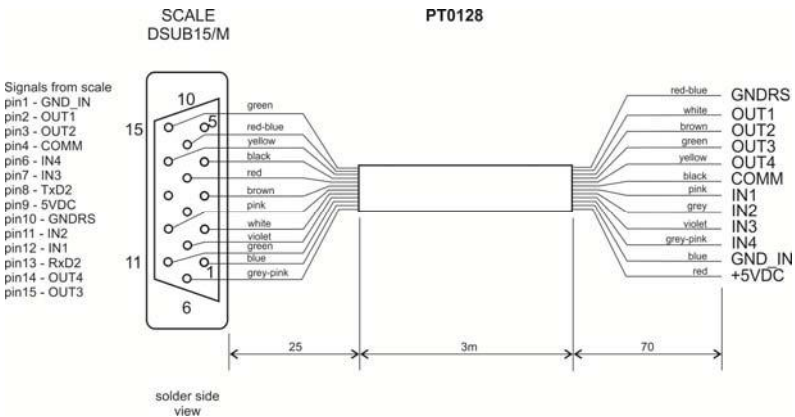

I/O cable

30. TROUBLESHOOTING

Problem	Cause	Solution
The scale does not switch on.	Battery discharged.	Connect the scale to the mains, charge the battery (batteries).
	No batteries (batteries not installed or installed incorrectly).	Check if batteries are installed correctly (polarization).
The scale switches off automatically.	<7.3.t1> parameter set to value enforcing scale shut-down after particular time interval.	Go to 'Othr' menu, set <7.3.t1> parameter to 'nonE' value.
During switching on, message 'LH' is displayed.	Weighing pan loaded during switching on process.	Unload the weighing pan. Zero indication is displayed.

31. ERROR MESSAGES

- Err 2 -	- Value beyond zero range.
- Err 3 -	- Value beyond tare range.
- Err 4 -	- Adjustment weight or start mass out of range ($\pm 1\%$ for adjustment weight, ± 10 for start mass).
- Err Lo -	- Determined mass of single part in 'Parts counting' mode too small. - Value of 'Min' threshold is greater than value of 'Max' threshold in '+/- control' mode.
- Err Hi -	- Entered value of single part greater than maximum capacity in 'Parts counting' working mode. - Entered value of 'Max' threshold greater than maximum capacity in '+/- control' mode. - Entered reference mass greater than maximum capacity in 'Percent weighing' mode.
- Err 8 -	- Time of the following operations exceeded: taring, zeroing, start mass determining, adjustment process.
- null -	- Zero value from converter.
- FULL -	- Weighing range exceeded.
- LH -	- Start mass error, indication out of range (-5% – $+15\%$ of start mass).
- Hi -	- Display range of total mass on scale display exceeded in 'Totalizing' mode.



RADWAG BALANCES AND SCALES
ADVANCED WEIGHING TECHNOLOGIES

